

 **KENWOOD**

SCHEMATHEEK
Beh. T. Hultermans
Postbus 4228
5604 EE Eindhoven

2m TRANSVERTER

Model TV-502



OPERATING MANUAL

IMPORTANT

To ensure correct operation and everlasting performance of your equipment, read this instruction manual thoroughly before using.

Particular attention should be paid to the following points whenever the equipment is set into operation:

1. The connecting cables supplied with the equipment are used for control power supply and signal connections. **When connecting or disconnecting the control power cable, make certain that the power switches of the equipment and TS-520 are set to the OFF position.**
2. **The SG switch at the rear of TS-520 should be set to OFF (down position) during the operation, except that modifications are made according to Paragraph 3-6 (page 8~9) of the instruction manual.**
3. Use an antenna of less than 2 of VSWR (voltage standing wave ratio) and 50-ohm of impedance.
4. Do not attempt to operate the transmitter without connecting the antenna.

FEATURES

- * TV-502 is designed to be used in combination with TS-520 for 144 MHz operation.
- * Operates in the frequency range from 144.0 MHz to 145.7 MHz, or up to 146.0 MHz by installing additional X'tal oscillating elements.
- * Amplification type ALC system is employed. ALC voltage feed back to TS-520 minimizes the distortion due to overdriving, assuring quality transmission.
- * All-solid-state configuration with FET employed in major circuits.
- * Provides maximum enjoyment of 144 MHz SSB mobile operation.
- * Enjoyable excellent operation performance of TS-520 on 144 MHz band by connecting to TS-520.
- * Receiving antenna circuit incorporates highly sensitive tuning circuit to minimize radio interference.
- * Unique, functional design perfectly matches the styling of TS-520, VFO-520 and SP-520.
- * With minor modification of wiring, changeover between HF and VHF is effected by simply manipulating the Power Switch of TV-502.

CONTENTS

	FEATURES	2
SECTION 1	BEFORE USING	3
	1.1 Accessories	
	1.2 Connections	
SECTION 2	OPERATING CONTROLS AND THEIR FUNCTIONS	4
	2.1 Front Panel	
	2.2 Rear Panel	
SECTION 3	OPERATION	6
	3.1 Reception	
	3.2 Transmission	
	3.3 Reading The Operating Frequency	
	3.4 Installetion of Heterodyne Crystal	
	3.5 HF/VHF Changeover	
	TROUBLE-SHOOTING	9
SECTION 4	CIRCUIT DESCRIPTION	10
	4.1 Block Diagram	
	4.2 Unit	
	CIRCUIT DIAGRAM	11
	SPECIFICATIONS	12

SECTION 1. BEFOR USING

1.1 ACCESSORIES

The following accessories should be included with TV-502 Transverter.

Instruction Manual	1
Warranty Card	1
Control Cable	1
Dual-pin Plug Cord	1
Earth Cable	1
12P Multi-connector Plug (shorting plug)	1
Stand	2
Stand Mounting Screw	2
Fuse (2 A)	2
Fuse (1 A)	1
2P Plug (DC)	1
Converter Plug	1

1.2 CONNECTIONS (SEE FIG. 1)

Connect TV-502 to TS-520 in the following sequence.

- ① Confirm that the power switches of TS-520 and TV-502 are OFF.
- ② Connect the X VERTER connector and X VERTER IN connector of TS-520 to the 2m CONTROL connector of TV-502 using the supplied control cable.
- ③ Connect the 2m TX IN jack of TV-502 to the X VERTER OUT jack of TS-520 using the supplied dual-pin plug cord.
- ④ Connect the GND terminal of TS-520 to the GND terminal of TV-502 using the supplied earth cable.

To prevent electric shock and to ensure stable operation, the earth cable must be connected between two units, though the units will operate without the connection.

- ⑤ Set the SG switch on the rear of TS-520 to the OFF position (down position).
- ⑥ Remove the HF antenna connected to TS-520.
- ⑦ Connect the 144 MHz antenna to the ANT terminal on the rear of TV-502. Be sure to use a coaxial cable of 50Ω impedance. VSWR should be less than "2".
For mobile operation, use a whip type antenna (1/4λ or 5/8λ) with a coaxial cable of 3D-2V or 5D-2V type. The length of the coaxial cable should be kept as short as possible.
For fixed station operation, it is recommended that a Yagi type beam antenna (with rotary actuator) be used for higher gain and better directivity. If the coaxial cable requires a length of more than 10 m, use 8D-2V or 10D-2V for the cable because it has low dissipation characteristic.
- ⑧ Confirm that the power switch and the standby switch of TS-520 are set in OFF and REC, respectively. Also, confirm that the power switch of TV-502 is OFF. Then, connect the AC power cord (or DC power cord for DC operation) to each unit.

NOTE: Set the operating power voltage to your local AC voltage with the voltage selector switch on the rear of TV-502. The unit is preset to AC 220 V at the factory before shipment.

Your TV-502 and TS-520 are now ready for operation.

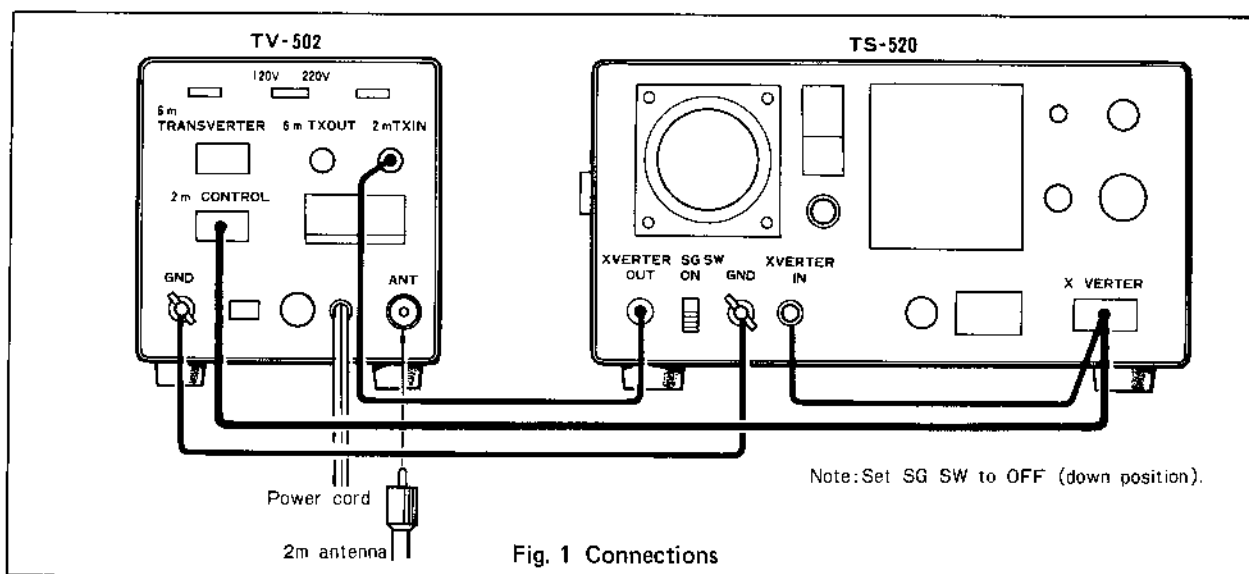

SECTION 2. OPERATING CONTROL AND THEIR FUNCTION

2.1 FRONT PANEL (SEE FIG. 2)

- ① **POWER SWITCH**
Turns on and off AC or DC power supply. It functions on both TS-520 and TV-502.
- ② **BAND SWITCH**
Selects the band-width of 144 MHz or 145 MHz. For 145 ~ 146 MHz band operation, crystal elements for local oscillator are prepared as optional accessories.
- ③ **PRESELECTOR KNOB**
This is a tuning knob for helical resonator installed in the receiving antenna circuit. It should be normally set to the maximum receiving sensitivity.
- ④ **IF TUNE KNOB**
This is a tuning knob for IF frequency of 28.0 ~ 29.7 MHz.
It should be set for maximum sensitivity or maximum ALC (ALC meter on TS-520).
- ⑤ **METER**
This is an RF transmitting output indicator. It is used to check the transmitting condition of TV-502.

2.2 REAR PANEL (SEE FIG. 3)

- ① **2 M CONTROL CONNECTOR**
A connector to connect TS-520 to TV-502. It is used for connections of various control sources such as receiving IF signal output, standby line, -100 V for blocking bias, etc.
- ② **6 M TRANSVERTER CONNECTOR**
This connector is used to connect TS-520 to TV-502 and 6 m (50 MHz) transverter (see Table 1).
- ③ **2 M TX IN JACK**
A pin-jack to feed transmitting IF signal to TV-502.
- ④ **6 M TX OUT JACK**
This jack is used to connect TS-520 to TV-502 and 6 m (50 MHz) transverter. By setting the power switch of TV-502 to OFF, the transmitting IF signal from TS-520 is obtained through the jack.
- ⑤ **ANT CONNECTOR**
Connect an antenna designed for 144 MHz band to this connector. The antenna system must be adjusted for less than "2" of VSWR. Note that if VSWR is higher than "2", the protection circuit for the transistors of the final stage of TV-502 is activated; in this case, expected performance cannot be obtained.
- ⑥ **AC-DC SELECTOR SWITCH**
Select the power supply. For AC operation, set the switch to AC position. For DC 13.8 V operation, first remove the switch stopper and then set the switch to DC position.

- ⑦ **2 M ONLY - 6 M CONNECT SELECTOR SWITCH**
When connecting TV-502 to 6 m transverter, set this switch to 6 m CONNECT position after removing the switch stopper.
- ⑧ **FUSE**
TV-502 is provided with a fuse rated at 0.5 A. When it is blown out, check the cause of it and replace it with the new one supplied.
- ⑨ **DC POWER CONNECTOR**
This connector is used for operating TV-502 on DC 13.8 V power. **Connect the supplied 2P plug making sure that the polarity is correct. A 3 A fuse must be connected to the "plus" side of the DC power cord.**
- ⑩ **POWER VOLTAGE SELECTOR SWITCH**
This switch selects the operating power voltage. The setting position of the switch should conform to your local power voltage. To change the setting position, the switch stopper must first be removed.
- ⑪ **GND TERMINAL**
TV-502 is grounded through this terminal. The supplied earth cable should be connected between this terminal and the GND terminal of TS-520.
- ⑫ **POWER CORD**
A power cord for AC power supply.

Pin No.	Rating
1	ALC
2	
3	210V 10mA
4	GND (TV-502 ON) OPEN (TV-502 OFF)
5	-100V 5 mA
6	TRANSVERTER IN
7	TS-520 ANT
8	OPEN (TS-520 ON) GND (TS-520 in reception)
9	GND
10	TS-520 final screen grid
11	
12	GND

TABLE 1 6M TRANSVERTER CONNECTOR TERMINALS RATING

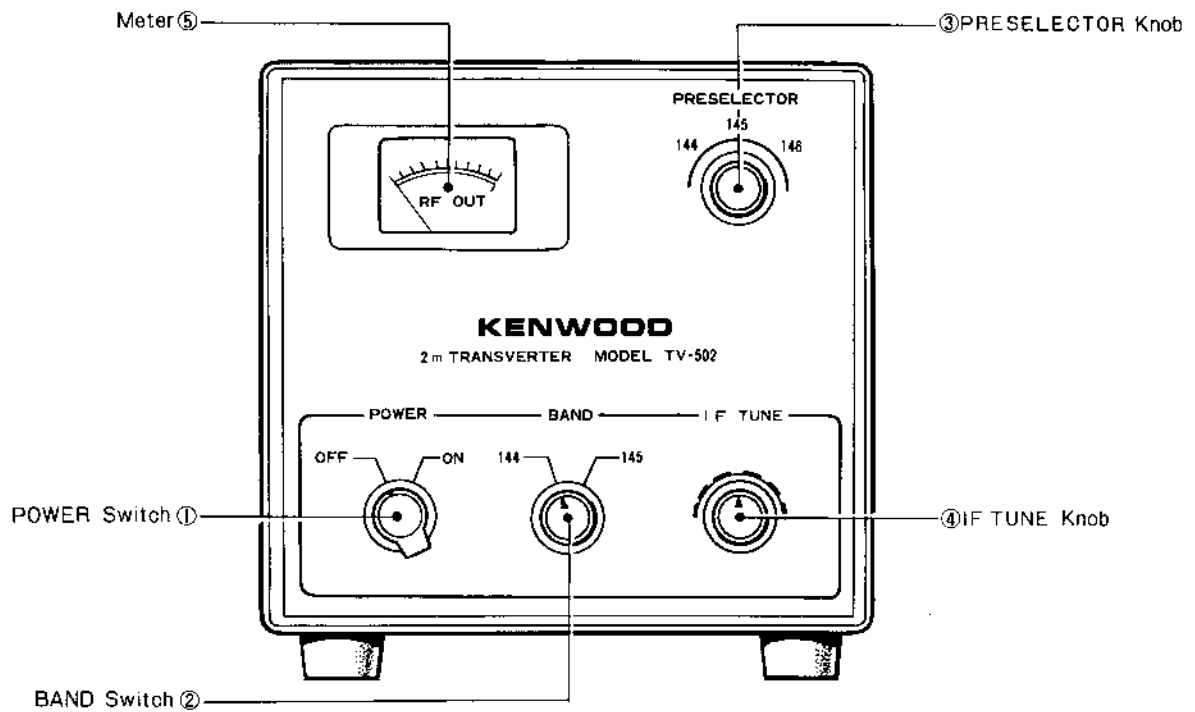

Fig. 2 Front Panel

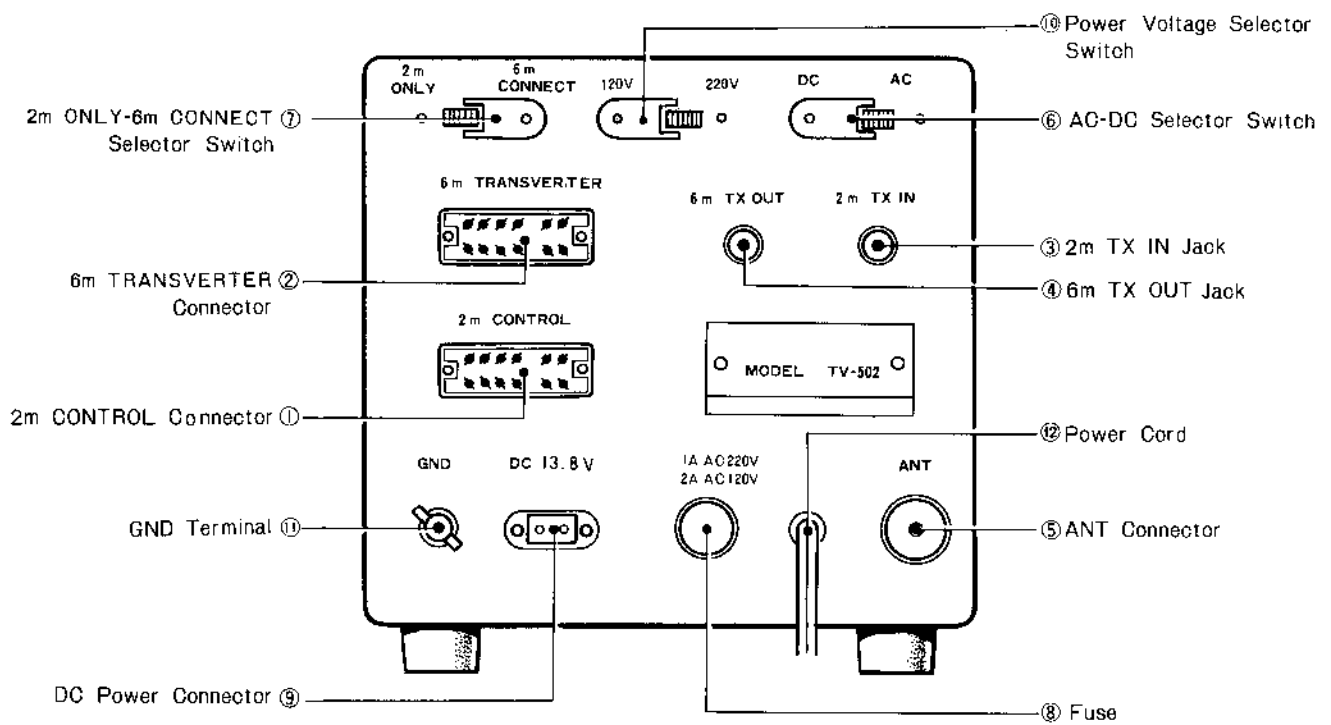

Fig. 3 Rear Panel

SECTION 3. OPERATION

3.1 RECEPTION

After the completion of connections between TV-502 and TS-520, set the control knobs of both units according to the instructions in Table 2 below.

FRONT PANEL: TS-520	
POWER Switch	OFF
Standby Switch	REC
H.SW Switch	OFF (ON for DC operation)
VOX Switch	MAN.
NB Switch	OFF
AGC Switch	SLOW or FAST
MODE Switch	Desired receiving mode of CW or USB
JJY/WWV Switch	OFF
RIT Switch	OFF
BAND Switch	Desired receiving BAND of 28, 28.5 or 29.1
FUNCTION Switch	VFO
AF GAIN Knob	Fully counterclockwise
RF GAIN Knob	Fully clockwise
DRIVE Knob	Center position
REAR PANEL: TS-520	
SG Switch	OFF (down position)
ANT Terminal	Remove HF antenna
EXT VFO Jack	Confirm that 9PMT plug is inserted.

FRONT PANEL: TV-502	
POWER Switch	OFF
BAND Switch	144
IF TUNE Knob	Center position
PRESELECTOR Knob	Center position
REAR PANEL: TV-502	
AC-DC Selector Switch	Set to AC or DC according to the type of operating power
2m ONLY-6m CONNECT Selector Switch	2m ONLY

TABLE 2 PRELIMINARY SETTING FOR RECEPTION

When the above setting has been completed, turn on the POWER switches of TS-520 and TV-502. The pilot lamp of each unit will light up indicating that the unit is operating. Slowly turn AF GAIN knob of TS-520 clockwise and noise or signal will be heard through the speaker. Adjust the knob for suitable volume. Next, slowly turn the main tuning knob of VFO and adjust it until the desired signal is heard most clearly.

Adjust the drive knob of TS-520, and the PRESELECTOR knob and IF TUNE knob of TV-502, until maximum sensitivity is obtained.

3.2 TRANSMISSION

Set the control knobs and switches of both units according to the instructions in Table 3 below. Ascertain that the **SG switch on the rear panel is set to OFF position** (down position).

FRONT PANEL: TS-520	
POWER Switch	ON
Standby Switch	REC
H.SW Switch	ON
VOX Switch	MAN
NB Switch	OFF
AGC Switch	SLOW or FAST
MODE Switch	CW
JJY/WWV Switch	OFF
RIT Switch	OFF
BAND Switch	Desired BAND of 28, 28.5 or 29.1
FUNCTION Switch	VFO
AF GAIN Knob	Adjust for suitable volume of receiving signal
RF GAIN Knob	Fully clockwise
DRIVE Knob	Center position
MIC Knob	Fully counterclockwise
CAR Knob	Center position
METER Switch	ALC
REAR PANEL: TS-520	
SG Switch	OFF (down position)
ANT Terminal	Remove HF antenna

FRONT PANEL: TV-502	
POWER Switch	ON
BAND Switch	144
IF TUNE Knob	Center position (or maximum receiving Sensitivity)
PRESELECTOR Knob	Center position (or maximum receiving sensitivity)
REAR PANEL: TV-502	
AC-DC Selector Switch	Set to AC or DC according to the type of operating power
2m ONLY-6m CONNECT Selector Switch	2m ONLY

TABLE 3 PRELIMINARY SETTING FOR TRANSMISSION

For transmission, proceed as follows.

- ① Set the standby switch of TS-520 to SEND position. Then, turn the DRIVE knob for maximum deflection of ALC meter or of RF meter of TV-502.
- ② Turn the IF TUNE knob of TV-502 for maximum deflection of ALC meter of TS-520 or of RF meter of TV-502.
- ③ You are now ready for CW or SSB operation; for CW operation, connect the key to TS-520; for SSB operation, set the MODE switch to USB, connect the microphone and increase the MIC gain. Adjust the CAR knob (CW) or the MIC knob (SSB) so that the ALC level meter indication is within the ALC zone.
- ④ To receive incoming signals, simply set the standby switch to REC position.
- ⑤ The DRIVE knob of TS-520 and the IF TUNE knob of TV-502 may be adjusted in either transmitting mode or receiving mode. Once these knobs are adjusted, you are assured of optimum transmission and reception in the adjusted frequency.

TV-502 uses 1.7 MHz frequency (28.0 ~ 29.7 MHz) band of TS-520 to facilitate the reading. Table 4 shows the relationship between the frequency and the band switch position.

During the operation, care should be taken so that the operating frequency is not deviated from the amateur band.

TS-520 BAND	TV-502 BAND	Operating Frequency (MHz)
28	144	144.0 ~ 144.5
28.5	144	144.5 ~ 145.1
29.1	144	145.1 ~ 145.7
28	145 (option)	145.0 ~ 145.5
28.5	145 (option)	145.5 ~ 146.0

TABLE 4 RELATIONSHIP BETWEEN BAND SWITCHES OF TS-520 AND TV-502

3.3 READING THE OPERATING FREQUENCY

The operating frequency can be read on the dial of TS-520. To read the frequency, replace the figure of the frequency (MHz) of 28 MHz BAND read on TS-520 with "144" or "145" position of the BAND switch of TV-502 as shown in Fig. 4.

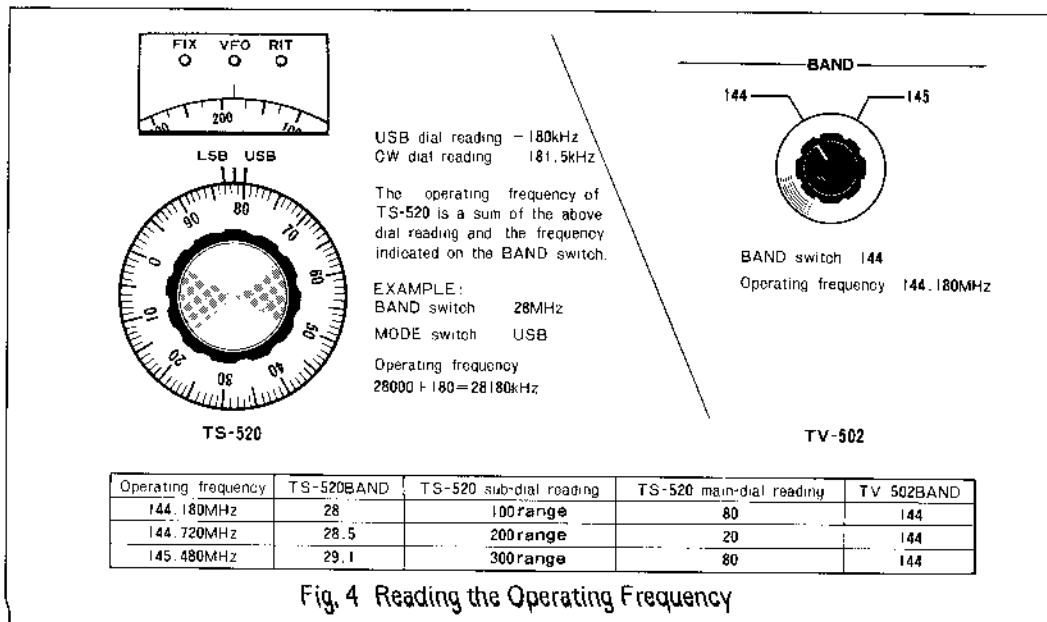
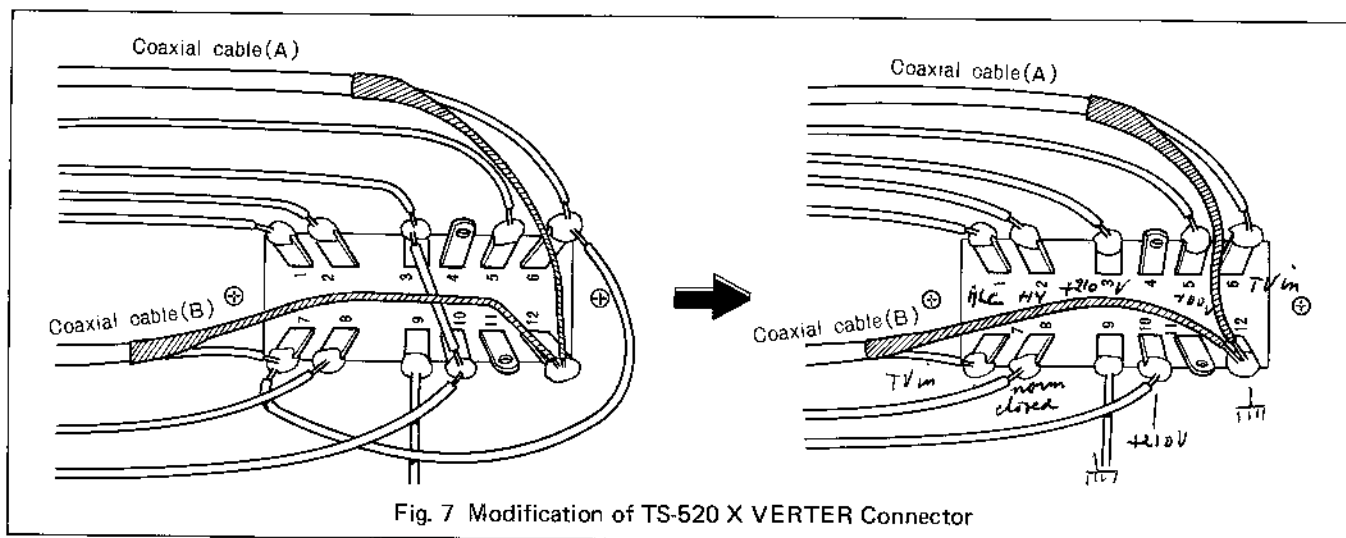

Fig. 4 Reading the Operating Frequency



TROUBLESHOOTING

TROUBLE	CAUSE	REMEDY
Lamp remains OFF when power switch is ON.	<ul style="list-style-type: none"> a. Improper connection of AC plug to receptacle (AC operation). b. Improper connection of DC power connector (DC operation). c. Incorrect setting of AC-DC selector switch. d. Fuse blown out. 	<ul style="list-style-type: none"> a. Connect AC plug firmly to receptacle. b. Connect firmly. c. Set the switch to the operating power supply. d. Replace fuse (if the fuse is blown out again after replacement, check the cause of trouble).
144 MHz band signal is not received (antenna connection is normal).	<ul style="list-style-type: none"> a. Improper connection of control cable. b. Band switch is in 145 MHz position (145 MHz band crystal element is not installed). 	<ul style="list-style-type: none"> a. Turn off the power switches of TS-520 and TV-502 and then connect the cable correctly. b. Set the band switch to 144 MHz position.
No transmitting output.	<ul style="list-style-type: none"> a. Improper connection of dual-pin cord. b. Heater switch of TS-520 is OFF. 	<ul style="list-style-type: none"> a. Connect the cord firmly. b. Turn the heater switch to ON.

SECTION 4. CIRCUIT DESCRIPTION

4.1 BLOCK DIAGRAM

Concerning the block diagram of TV-502, refer to the figure below.

4.2 UNIT

4.2.1 RF UNIT (X44-1120-00)

This unit is used to convert 144 MHz band signals from the antenna to 28 MHz band signals during reception and 28 MHz band signals from TS-520 to 144 MHz band signals during transmission.

Receiving Operation

The 144 MHz band signal fed to the antenna is applied through the helical resonator to the RF unit. The signal again passes through the B.P.F. (helical resonator) and is amplified by the RF amplifier so that it is converted into 28.0 ~ 29.7 MHz signal through the mixer circuit.

Transmitting Operation

The 28.0 ~ 29.7 MHz signal from TS-520 is converted into 144 MHz band signal through the balanced mixer circuit consisting of 2 FETs. It is then power amplified to the required level through the amplifier composed of FET stage and transistor stage so that it is applied to the final unit. The amplifier uses dual gate MOS FET and is provided with a protection circuit for protection of the final stage transistor against possible mismatching of the antenna and others.

4.2.2 FINAL UNIT (X56-1150-00)

This unit is composed of 2SC1169 driver amplifier and 2SC1242A final stage power amplifier to obtain the necessary output power.

4.2.3 HET OSCILLATOR UNIT (X50-1250-00)

This is the local oscillator circuit to convert frequency from 144 MHz to 28 MHz and from 28 MHz to 144 MHz. It oscillates 116 MHz frequency by tripling the 38.666 MHz of original oscillating frequency.

4.2.4 CONTROL UNIT (X53-1040-00)

This unit incorporates the circuit to detect reflected waves due to mismatching of antenna, circuit to detect ALC voltage and rectifier circuit for RF meter.

4.2.5 RECTIFIER AND AVR CIRCUIT (X43-1150-00)

The voltage of AC 16 V from the power transformer is rectified through the 4-diode bridge type rectifier circuit and then passes through the power stabilizer circuit to obtain stabilized voltages of 9 V and 15 V.

The unit is provided with a relay drive transistor controlled by the standby switch of TS-520.

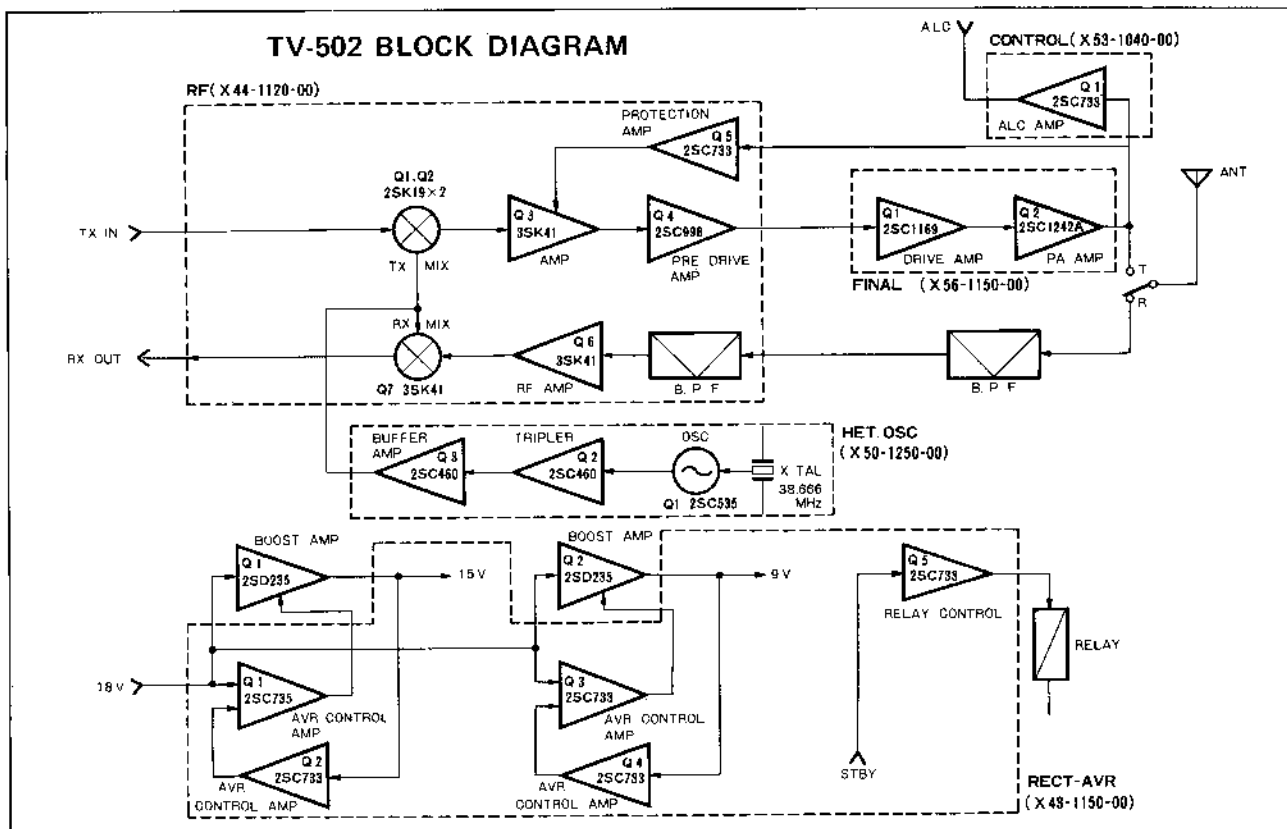

TV-502 CIRCUIT DIAGRAM

SCHEMATHEEK
 Beh. T. Hultermans
 Postbus 4228
 5604 EE Eindhoven

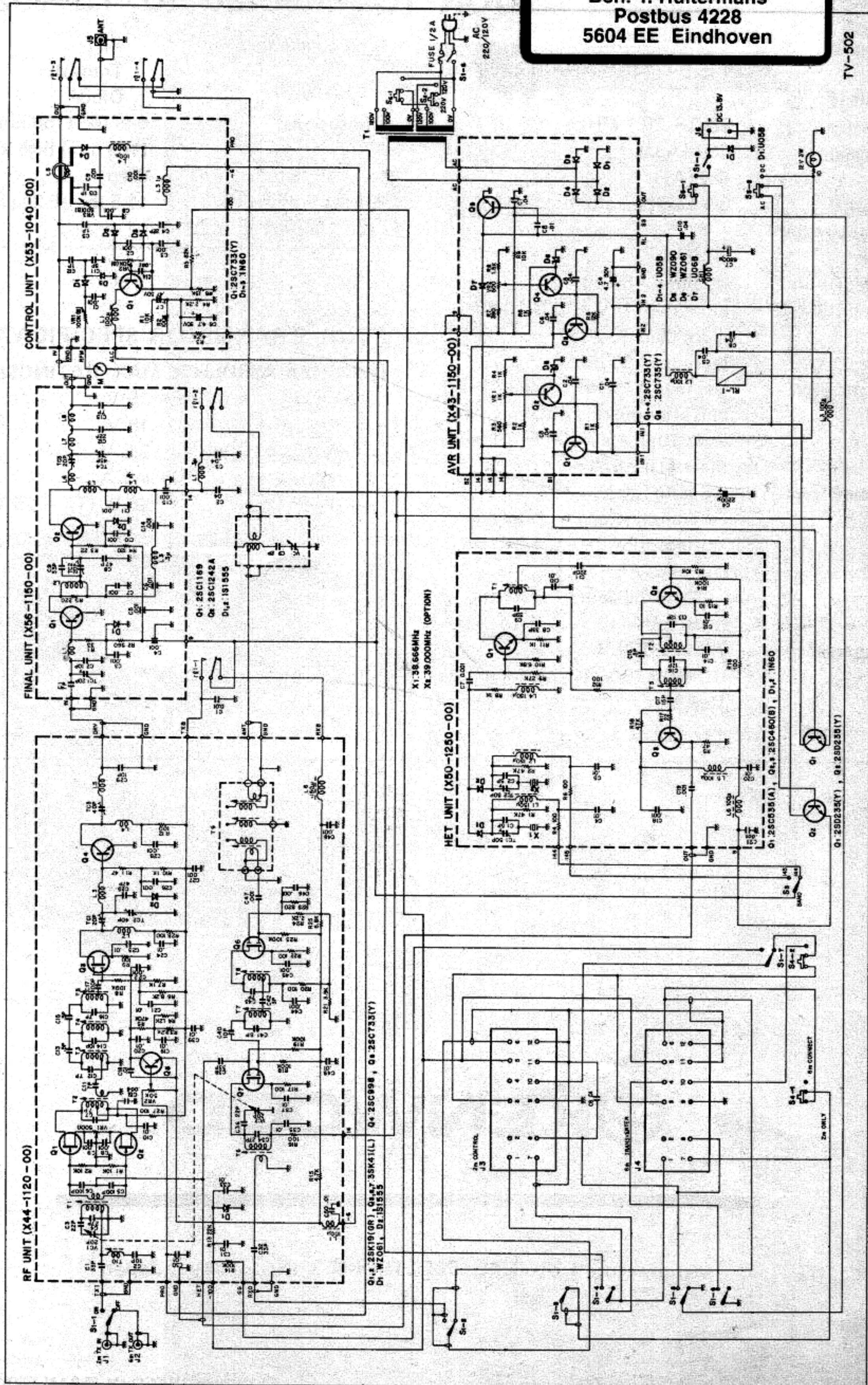

TV-502

TV—502 SPECIFICATION (Connected to TS—520)

Transmitting/receiving frequency:	144 ~ 145.7 MHz 145.0 ~ 146.0 MHz (option)
Input/output IF frequency:	28.0 ~ 29.7 MHz
Type of emission	SSB (A3J) CW (A1)
Rated output:	8W (AC operation)
Antenna input/output impedance:	50 Ω
Unwanted radiation:	less than -60 dB
Receiving sensitivity:	more than 1 μ V at S/N 10 dB
Image ratio:	more than 60 dB
IF rejection:	more than 60 dB
Frequency stability:	less than ± 2.5 kHz during 1 ~ 60 min after power switch is ON and within 150 Hz (per 30 min) thereafter.
Power consumption:	AC 220/120 V
	Transmission 50W max Reception 12W max
Power requirement:	DC 13.8 V
	Transmission 2A max Reception 0.4A max
Power requirement:	AC 220/120 V
	DC 12 ~ 16 V (standard voltage 13.8 V)

Semi-conductor:	FET	5
	Transistor	15
	Diode	19
Dimensions:	6-9/16" (168 mm) wide x 5-15/16" (153 mm) high x 13-1/8" (336 mm) deep	
Weight:	11.5 lbs. (5.2 kg)	

FINAL TRANSISTOR SPECIFICATION

(2SC1242A ABSOLUTE MAX. RATINGS)

V_{CBO} :	35 V
V_{CEO} :	18 V
V_{EBO} :	3.5 V
I_C :	4.5 A
P_C :	30 W ($T_C = 25^\circ\text{C}$)
T_j :	175 $^\circ\text{C}$
T_{stg} :	-65 ~ 175 $^\circ\text{C}$



Manufactured by TRIO ELECTRONICS, INC., Tokyo, Japan

TV—502 SPECIFICATION (Connected to TS—520)

Transmitting/receiving frequency:	144 ~ 145.7 MHz 145.0 ~ 146.0 MHz (option)
Input/output IF frequency:	28.0 ~ 29.7 MHz
Type of emission	SSB (A3J) CW (A1)
Rated output:	8W (AC operation)
Antenna input/output impedance:	50 Ω
Unwanted radiation:	less than -60 dB
Receiving sensitivity:	more than 1 μ V at S/N 10 dB
Image ratio:	more than 60 dB
IF rejection:	more than 60 dB
Frequency stability:	less than ± 2.5 kHz during 1 ~ 60 min after power switch is ON and within 150 Hz (per 30 min) thereafter.
Power consumption:	AC 220/120 V Transmission 50W max Reception 12W max DC 13.8 V Transmission 2A max Reception 0.4A max
Power requirement:	AC 220/120 V DC 12 ~ 16 V (standard voltage 13.8 V)

Semi-conductor:	FET 5 Transistor 15 Diode 19
Dimensions:	6-9/16" (168 mm) wide x 5-15/16" (153 mm) high x 13-1/8" (336 mm) deep
Weight:	11.5 lbs. (5.2 kg)

FINAL TRANSISTOR SPECIFICATION

(2SC1242A ABSOLUTE MAX. RATINGS)

V_{CBO} :	35 V
V_{CEO} :	18 V
V_{EBO} :	3.5 V
I_C :	4.5 A
P_C :	30 W ($T_C = 25^\circ\text{C}$)
T_j :	175 $^\circ\text{C}$
T_{stg} :	-65 ~ 175 $^\circ\text{C}$



Manufactured by TRIO ELECTRONICS, INC., Tokyo, Japan